

TABLE OF CONTENTS

INITIAL SETUP

- Introduction 3
- Packing List 3
- Terms 3
- 420 Key Features 4
- 420 Display 6
- Installing the Battery 6

INSTALLATION

- Desk/Wall Mounting Bracket 7
- Connecting the Telephone 7
 - Back Panel Connections 7
 - Side Panel Connections 7
 - Two RJ14 2-Line Telephone Jacks 8
 - One RJ61 4-Line Telephone Jack 8

INITIAL PROGRAMMING

- To Enter the Program Mode 10
- To Exit the Program Mode 10
- Setting the Language 10
- Setting the Time and Date 10
- Setting the Extension ID 11
- Setting Message Waiting Indicator On/Off 11

PROGRAMMING OPTIONS

- Turning the Ringers On or Off 12
- Change the Ringer Types 12
- Setting the Delay Ring 13
- Programming the Line Usage 14
- Setting the Prime Line 15
- Programming Line Groups/Private Line 16
- Setting Auto-Mute 17
 - Auto Intercom Answer 17
- Setting Tone/Pulse Dialing 18
- Changing the Flash Duration 18
- Changing Hold Reminder 19
- Programming Area Codes 19
- Resetting the 420 20

TELEPHONE OPERATION

- New Call/Message Waiting Indicator 21
- Voice Mail 21
- Turning the Message Waiting Indicator On/Off 21
- Line Status Indicators 22
- Volume Control 22
 - Off-Hook Volume 22
 - Ringer Volume 22
- Making Telephone Calls 23
- Prime Line 23
- Receiving Telephone Calls 23
- Receiving Call Waiting Calls 23
- Transferring Calls 24
 - To Transfer a Call 24
 - Answer a Transferred Call 24
- Hold 24
 - To Place a Call on Hold 24
 - To Release a Call on Hold 24
- Mute 25
 - To Mute a Call 25
 - To Release Mute 25
- Flash/Feature 25
- Redial/Last Number Redial 25
- Auto Redial 25
- 3-Way Call Conferencing 26
- Tone/Pulse Mixed Dialing 26
- DND - Do Not Disturb 26
 - To Activate DND 26
 - To Deactivate DND 26
- Call Privacy - Extension Conferencing 27
 - To Deactivate Call Privacy 27
 - To Restore Call Privacy 27
- Paging and Intercom 27
- Paging All Extensions 27
- Answering a System Wide Page 27
- Paging a Single Extension 28
- Answering a Single Extension Page 28
 - Auto-Mute Off at Receiving Extension ... 28
 - Auto-Mute On at Receiving Extension . 28

TABLE OF CONTENTS

TELEPHONE OPERATION

Room Monitor	28
Making an Intercom Call	29
Answering an Intercom Call	29
Making an Intercom Conference Call	29

CALLER ID

Caller ID	30
The Caller ID Display	30
Viewing Caller ID Information	30
Viewing Caller ID Information of an Incoming Call	30
Viewing Caller ID Information of Simultaneous Incoming Calls	30
Call Waiting Caller ID	30
Stored Caller ID Records	31
Viewing Stored Caller ID Records	31
Information Other than the Caller's Name and Number may be Displayed	31
Dialing Using Caller ID Records	31
Deleting Caller ID Records	32
Deleting an Individual Caller ID Record	32
Deleting All Caller ID Records	32

DIRECTORY

Directory	32
Creating a New Directory Entry	32
Transferring a Caller ID Record to the Directory	33
Locating a Directory Record	33
To Scroll through the Alphabetical List of Directory Records	33
Locating a Directory Record (by Jumping)	33
Dialing a Directory Number	33
Deleting Directory Records	34
Deleting an Individual Directory Record	34
Deleting All Directory Records	34
Transferring a Number from LNR (Last Number Redial) to the Directory	34

ADDITIONAL FEATURES

Programming the Feature Keys	35
Dialing Using the Feature Keys	35
Transferring a Number from LNR (Last Number Redial) to a Feature Key	36
Using a Headset	36
Power Failure Operation	36
Battery Low Indication	36
Troubleshooting	37
Programming Tree	39
FCC Requirements	45

INITIAL SETUP

INTRODUCTION

Congratulations! You have purchased the 420, a versatile fully featured 4 line telephone. The 420 is designed to work as a *system phone* when used with additional 420 telephones. As a system, the 420 supports advanced telephone features such as intercom, paging and call transfer. Up to twelve 420s can be connected as a system.

Plan your system before you install the telephones, remembering the following requirements:

- The 420 telephones communicate over the wire on line 1. Line 1 must be common to all 420 telephones for the system features to operate.
- The total length of telephone wiring connected to line 1 should not exceed 600 feet.
- Each 420 in the system must be assigned a unique EXTENSION NUMBER. Valid numbers are from 11 – 22.
- If multiple extensions will be installed, install and program the extension numbers one at a time.

The 420 is designed to support telephone company features, including CENTREX. Caller ID and Call Waiting Caller ID and other telephone company features require subscription to these services.

NOTES:

- You must subscribe to the combined service of Call Waiting and Call Waiting Caller ID to use the Call Waiting Caller ID feature. Check with your local telephone company for service availability.
- DSL service on line 1 or 2 may interfere with system communications. Use line 3 or 4 for DSL.

PACKING LIST

Please take a moment to locate and identify the components shipped with your Telephone. Enclosed within the packaging:

- | | | |
|---------------------------|---------------------------------|------------------------------|
| ■ Executive Telephone Set | ■ 2 Telephone Line Cords (long) | ■ 3 Feature Key Index Cards; |
| ■ Handset | ■ 1 Line Cord (short) | 1 installed, 2 spares |
| ■ Handset Cord | ■ Owner's Guide | ■ Desk/Wall Mount Bracket |
| ■ AC Adapter | | |

TERMS

CID – Caller Identification or Caller ID.

EXTENSION – An individual 420 telephone having a unique extension number.

IDLE MODE – Extension not in use.

OFF-HOOK - Going “off-hook” refers to lifting the handset, activating the speakerphone or pressing the headset button for the purpose of making or answering a call. When the phone is successfully taken off-hook, a telephone line will be “seized” in which either an incoming call is answered or a dial tone heard.

VMI – Visual Message Indication.

POT – “Plain old telephone” refers, in so far as this manual is concerned, to a non 420 type telephone. A POT can be connected to any line shared by a 420 system, but cannot utilize the 420 system features such as intercom, paging or call transfer.

SYSTEM – Up to twelve 420 telephones connected with a common line 1, each having a unique extension number between 11 and 22.

420 KEY FEATURES

CALLER

Used to view Caller ID information when more than one line is ringing.

PROGRAM

Used to enter the program mode, page 10.

DND - DO NOT DISTURB

Silences the call and intercom ringers, page 26.

NAVIGATION KEYS

Used to navigate CALLER ID records, DIRECTORY records and Programming options.

SAVE

Used to program or change settings.

ERASE

Used to erase Caller ID or Directory records.

MSGW LIGHT CLEAR

Used to clear MESSAGE WAITING indicator.

CONFERENCE

Initiates 3-Way conference calls, page 26.

TRANSFER

Calls can be transferred from one 420 extension to another.

FLASH/FEATURE

Used to access telephone company features, page 25.

PAGE ALL

Page all 420 stations simultaneously, page 27.

PAGE

Page individual 420 stations, page 28.

VOLUME KEYS

Adjust the handset, headset, speakerphone or ringer volume levels, page 22.

INTERCOM

Call other 420 stations without using an outside line.

HEADSET

Answer or make calls without lifting the handset, page 36.

MUTE

Turns off the 420 microphone. The receiver stays on and calling party can still be heard, page 25.

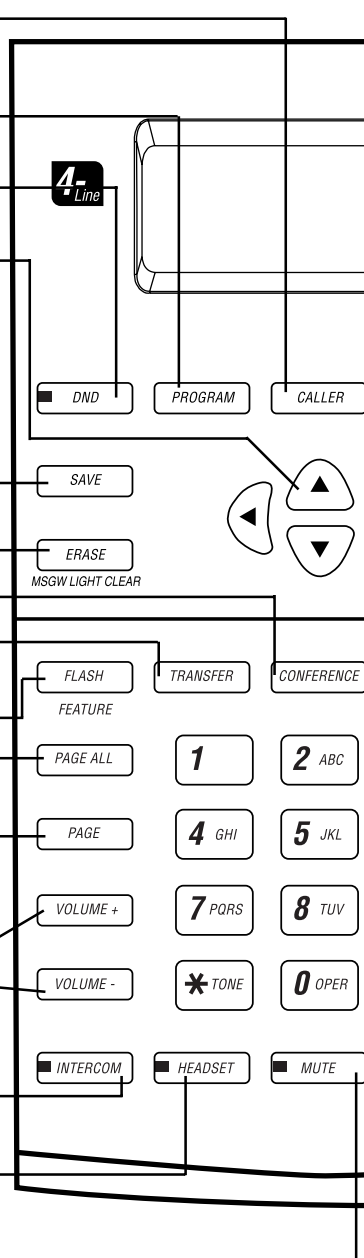

420 KEY FEATURES

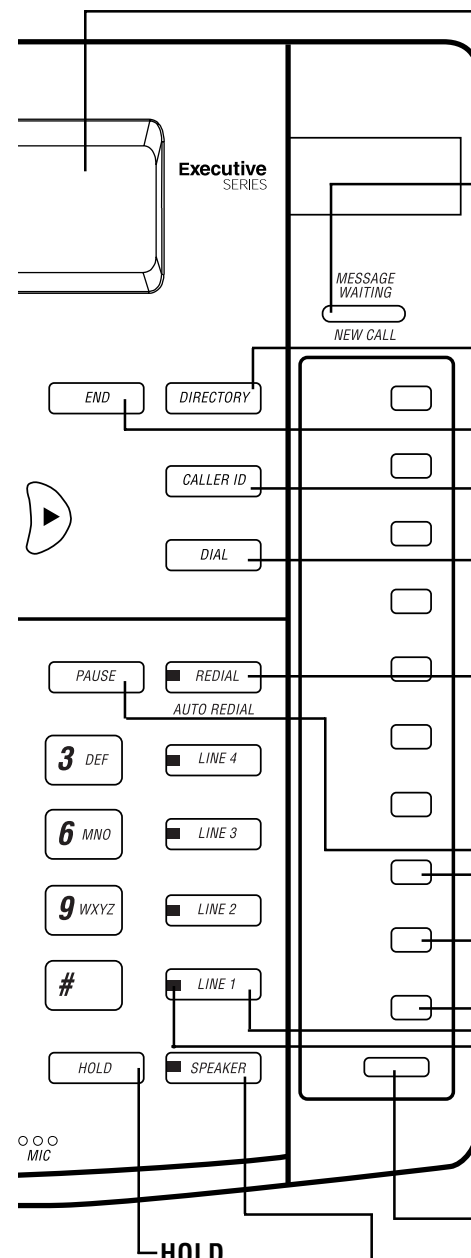

LCD

Large multi-function Liquid Crystal Display indicates telephone status and displays CALLER ID and DIRECTORY records, page 6.

NEW CALL/MESSAGE WAITING INDICATOR

Indicates new Caller ID data or new telephone company voice mail, page 21.

DIRECTORY

Accesses the DIRECTORY database, page 32.

END

Used to exit a mode.

CALLER ID

Accesses the CALLER ID database, page 31.

DIAL

Used to dial CALLER ID and DIRECTORY numbers, pages 31-33.

REDIAL/LAST NUMBER REDIAL

Automatically dials the last number called, page 25.

AUTO REDIAL

Automatically dials the last number called up to 10 times at 30 second intervals, page 25.

PAUSE

Allows a pause to be inserted in a dialing sequence, page 32.

FEATURE KEYS

Store multi-function autodial numbers, page 35.

LINE SELECT KEYS

Allows manual selection of lines 1, 2, 3 or 4, page 23.

LINE STATUS INDICATORS

Shows status of telephone lines at a glance, page 22.

SHIFT

Programs and dials Feature Keys, page 35.

SPEAKER(PHONE)

Answer or make calls hands free, page 23.

HOLD

Places or releases a call on hold, page 24.

INITIAL SETUP

420 DISPLAY

IDLE MODE

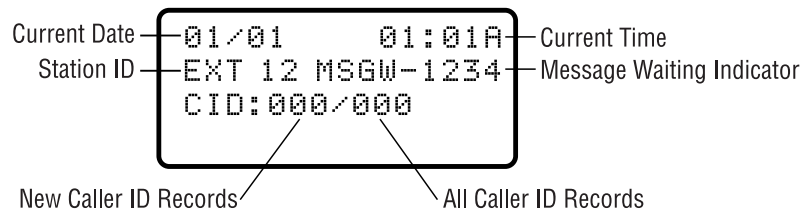

CALLER ID DISPLAY

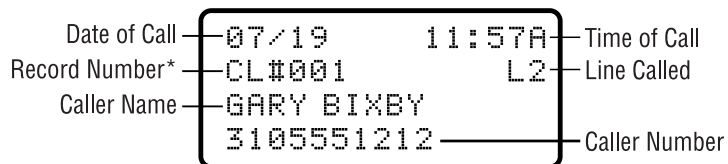

***NOTE:**

- The Record Number will only appear when reviewing Caller ID Records.

IN-USE DISPLAY

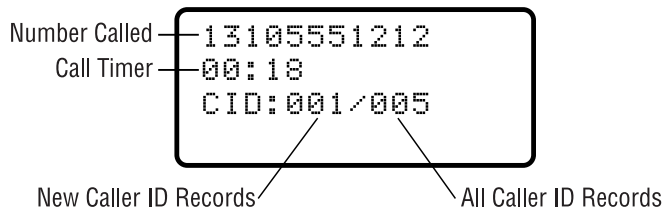

INSTALLING THE BATTERY

The 9 volt battery (not included) is required for the telephone to operate when there is a power failure. Use alkaline battery only. See POWER FAILURE OPERATION on page 36.

1. Remove the screw securing the battery compartment cover.
2. Open the battery compartment cover by pressing the tab.
3. Install the battery as shown.
4. Replace the battery compartment cover and tighten the screw.

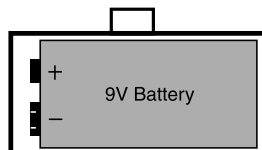

INSTALLATION

DESK/WALL MOUNTING BRACKET

The 420 desk/wall bracket is factory configured in the DESK position. To convert to wall mounting, slide the bracket as shown. Rotate and replace the bracket in the WALL position. Install two screws into the wall using the template as a guide. Purchase wood screws, round head, brass, size #10, 1/4 inch in length. Thread the telephone line cords through the channel on the bottom of the unit.

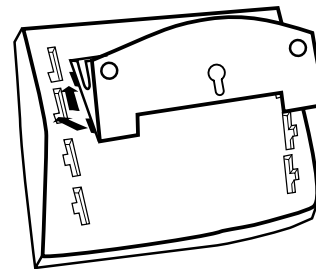

Desk Mount

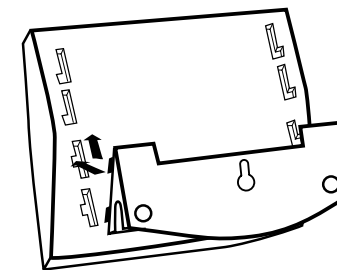

Wall Mount



T
E
M
P
L
A
T
E



CONNECTING THE TELEPHONE

BACK PANEL CONNECTIONS

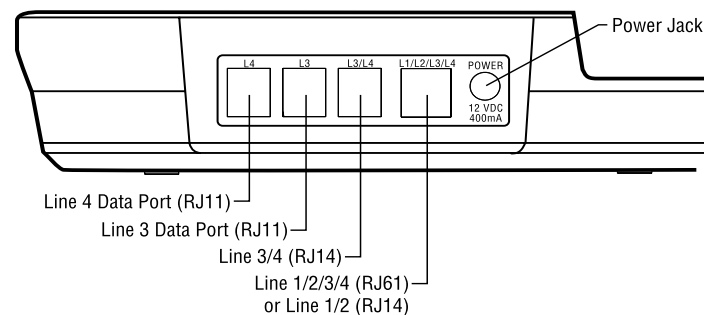

SIDE PANEL CONNECTIONS

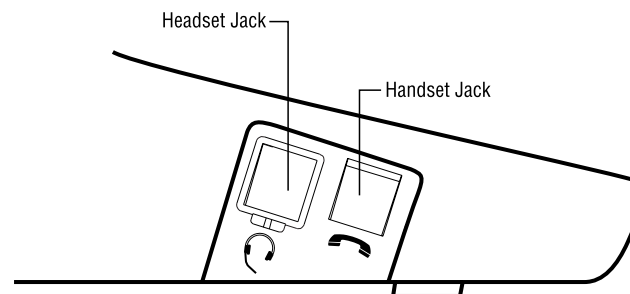

INSTALLATION

CONNECTING THE TELEPHONE (cont.)

1. Connect the 420 to the telephone wall jacks as shown in the illustrations below.

Two RJ14 2-Line Telephone Jacks

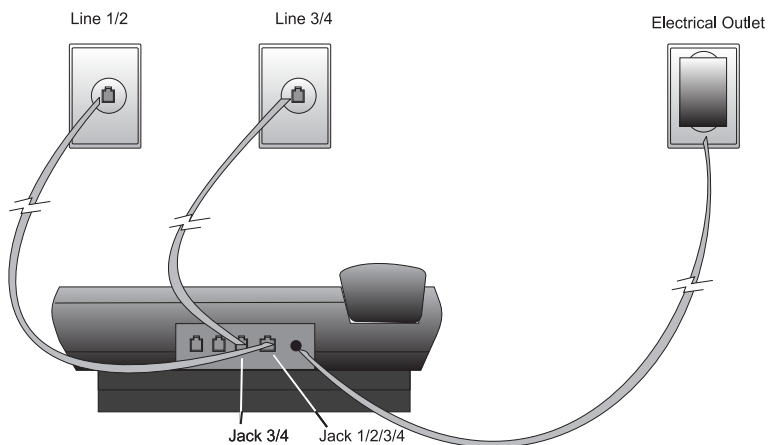

NOTE:

- First connect the Line 1/2 RJ14 cable (included) to the Line 1/2/3/4 RJ61 jack on the back panel of the 420. Then connect the Line 3/4 RJ14 cable (included) to the Line 3/4 RJ14 jack.

One RJ61 4-Line Telephone Jack

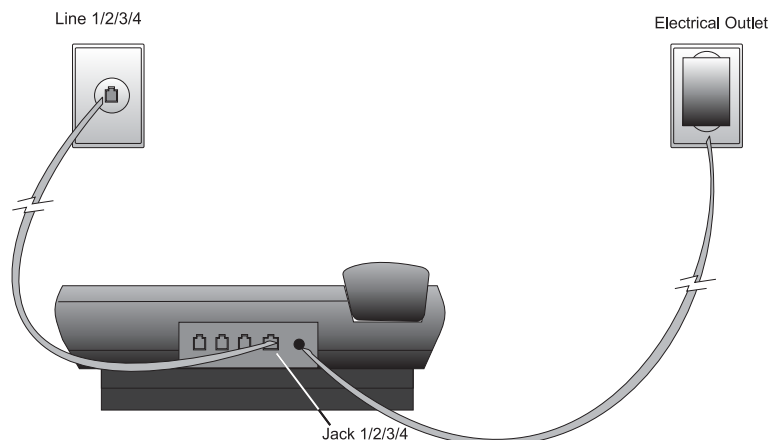

NOTES:

- Connect the Line 1/2/3/4 RJ61 cable (not included) to the Line 1/2/3/4 RJ61 jack on the back panel of the 420.
- If you are using a single cable to connect all 4 lines, you must use a USOC RJ-61 cable. DO NOT USE a RJ-45 cable.

INSTALLATION

CONNECTING THE TELEPHONE (cont.)

2. Connect the handset cord.
3. Connect the power adapter. Make sure that the outlet into which you plug the AC adapter is not controlled by a wall switch.
4. When power is connected, the display will indicate initialization. This process will take about 8 seconds.
5. The initial display will appear. The default extension ID is 22.

```
01/01    01:01A
EXT 22
CID: 000/000
```

NOTE:

- If more than one extension in a system is assigned the same ID number, the phone will beep continuously. Press **PROGRAM** to reassign a unique ID number.

INITIAL PROGRAMMING

TO ENTER THE PROGRAM MODE

You are now ready to begin configuring the extension using the PROGRAM mode. Press **PROGRAM** to enter.

TO EXIT THE PROGRAM MODE

Press **END** to exit the PROGRAM mode. Going off-hook will also exit the PROGRAM mode. The PROGRAM mode will also automatically exit after 20 seconds of inactivity.

The PROGRAM options are structured like a tree (see Programming Tree page 39). The ▲▼ keys are used to navigate options. The programming tree is a loop that returns to the first option as you navigate up or down.

SETTING THE LANGUAGE

The default language is English.

1. Press **PROGRAM**.

```
PROGRAM
▲▼:select
```

2. Press the ▼ button once.

```
LANGUAGE
▲▼:select
▶: enter
```

3. Press the ▶ button to enter.

```
LANGUAGE
= English
▲▼:select
SAVE?
```

4. Use the ▲▼ buttons to select the desired language.

5. Press **SAVE** when done.

```
LANGUAGE
= English
Programmed!
```

SETTING THE TIME AND DATE

1. While in the PROGRAM mode, press the ▼ button until the following screen appears:

```
TIME/DATE
▲▼:select
▶: enter
```

2. Press the ▶ button to enter.

```
MONTH
01/01 1:00A
▲▼:select
SAVE?
```

INITIAL PROGRAMMING

SETTING THE TIME AND DATE (cont.)

3. Use the ▲▼ buttons to select the correct MONTH.
4. Press **SAVE** to accept your setting and to advance to the DATE.
5. Use the ▲▼ buttons to select the correct date.
6. Press **SAVE** to accept your settings and advance to the HOUR.
7. Use the ▲▼ buttons to select the correct hour.
8. Press **SAVE** to accept your settings and advance to the MINUTES.
9. Use the ▲▼ buttons to select the correct minutes.
10. Press **SAVE** to accept your settings and advance to AM/PM.
11. Use the ▲▼ buttons to select AM or PM.
12. Press **SAVE** to accept your settings and advance to DAY OF WEEK.
13. Use the ▲▼ buttons to select the correct day.
14. Press **SAVE** to accept your settings.

```
DAY OF WEEK
= Sunday
Programmed!
```

SETTING THE EXTENSION ID

1. While in the PROGRAM mode, press the ▼ button until the following screen appears:
4. Press **SAVE** to accept your choice.

```
EXTENSION NO
▲▼:select
▶: enter
```

```
EXTENSION
= 11
Programmed!
```

2. Press the ▶ button to enter.

```
EXTENSION NO
=22
▲▼:select
SAVE?
```

3. Use the ▲▼ buttons to select an extension between 11 and 22.

5. Initial programming is now complete. You can press the PROGRAM button to exit the PROGRAM mode and begin using the 420 with the factory default settings (see TELEPHONE OPERATION on pages 21-29) or you can program additional options.

NOTE:

- If more than one extension in a system is assigned the same ID number, the phone will beep continuously. Press **PROGRAM** to reassign a unique ID number.

SETTING MESSAGE WAITING INDICATOR ON/OFF

The light and display indication can be turned ON and OFF in the PROGRAM MODE. See page 21.

PROGRAMMING OPTIONS

TURNING THE RINGERS ON OR OFF

The ringer for each of the 4 lines can be turned ON or OFF. The default setting is ON.

1. While in the PROGRAM mode, press the ▼ button until the following screen appears:

```
RINGER ON/OFF
```

```
▲▼: select  
▶: enter
```

2. Press the ▶ button to enter.

```
L1 RINGER ON/OFF
```

```
▲▼: select  
▶: enter
```

3. Use the ▲▼ buttons to select the desired ringer, 1-4.

4. Press the ▶ button to enter.

```
L1 RINGER ON/OFF
```

```
= On  
▲▼: select  
SAVE?
```

5. Use the ▲▼ buttons to change the setting to OFF.

```
L1 RINGER ON/OFF  
= Off  
▲▼: select  
SAVE?
```

6. Press **SAVE** to accept the setting.

```
L1 RINGER ON/OFF  
= Off  
Programmed!
```

7. Repeat for the other lines, or select ALL RINGER ON/OFF to determine setting for all 4 lines.

CHANGE THE RINGER TYPES

There are 4 ringer tones, or types, that can be selected. The default is 1. Changing the ringer types by line is useful if you want to distinguish which line is ringing audibly without having to see the LINE indicators on the telephone itself.

1. While in the PROGRAM mode, press the ▼ button until the following screen appears:

```
RINGER TYPE
```

```
▲▼: select  
▶: enter
```

2. Press the ▶ button to enter.

```
L1 RINGER TYPE  
▲▼: select  
▶: enter
```

3. Use the ▲▼ buttons to select the desired line, 1-4.

PROGRAMMING OPTIONS

CHANGE THE RINGER TYPES (cont.)

4. Press the ▶ button to enter.

```
L1 RINGER TYPE  
= Type 1  
▲▼: select  
SAVE?
```

5. Use the ▲▼ buttons to select the ringer type. As you scroll through the types, a sample of the actual ringer will be heard.

```
L1 RINGER TYPE  
= Type 2  
▲▼: select  
SAVE?
```

6. Press **SAVE** to accept the setting.

```
L1 RINGER TYPE  
= Type 2  
Programmed!
```

7. Repeat for the other lines.

SETTING THE DELAY RING

The DELAY RING is useful in installations where all 4 lines are common (square) and a receptionist is answering all calls. Each extension would activate the DELAY RING for the desired period of time except for the receptionist.

Incoming calls would ring at the receptionist extension ONLY for the DELAY RING time. If the receptionist doesn't answer, after that time other extensions would begin to ring. By varying the delay ring time, a hierarchy of back-up for the receptionist can be defined.

Most ring cycles are 6 seconds per ring. So to delay for two rings, program 12 seconds. For three rings, program 18 seconds, and so on. Programming is in two second increments. The default is DELAY RING OFF.

NOTE TO VOICE MAIL SUBSCRIBERS:

- If you set the DELAY RING for LONGER than the number of rings that the voice mail waits before answering, the phone will never ring.

1. While in the PROGRAM mode, press the ▼ button until the following screen appears:

```
DELAY RING
```

```
▲▼: select  
▶: enter
```

2. Use the ▲▼ buttons to change the desired ring delay.

```
DELAY RING  
= 12 sec  
▲▼: select  
SAVE?
```

3. Press **SAVE** to accept the setting.

PROGRAMMING OPTIONS

PROGRAMMING THE LINE USAGE

Lines that are not used (connected) to the 420 must be turned OFF. If lines are added later they can be turned ON.

For system feature operations like call transfer, paging and intercom, line one must be connected and common to all 420 extensions in the system.

NOTE:

- If a line is NOT connected to the 420 and the LINE USAGE is NOT turned OFF, the LINE IN USE INDICATOR will flash.

1. While in the PROGRAM mode, press the ▼ button until the following screen appears:

```
LINE USAGE
▲▼: select
▶: enter
```

2. Press the ▶ button to enter.

```
L1 USAGE
▲▼: select
▶: enter
```

3. Use the ▲▼ buttons to select the desired line, 1-4.

4. Press the ▶ button to enter.

```
L4 USAGE
= On
▲▼: select
SAVE?
```

5. Use the ▲▼ buttons to turn the line on or off.

```
L4 USAGE
= Off
▲▼: select
SAVE?
```

6. Press **SAVE** to accept the setting.

```
L4 USAGE
= Off
Programmed!
```

7. The LINE IN USE INDICATOR for the line will stop flashing and will not relight until the LINE USAGE is turned back on. Repeat for the other lines.

PROGRAMMING OPTIONS

SETTING THE PRIME LINE

The PRIME LINE is the line that the 420 attempts to use when going off-hook when the phone is not ringing. Line 1 is the default.

If the phone is ringing and you go off-hook, the 420 will answer the ringing line. If more than one line is ringing, the 420 will answer the line that was ringing first.

1. While in the PROGRAM mode, press the ▼ button until the following screen appears:

```
PRIME LINE
▲▼: select
▶: enter
```

2. Press the ▶ button to enter.

```
PRIME LINE
= L1
▲▼: select
SAVE?
```

3. Use the ▲▼ buttons to select the desired PRIME LINE.

```
PRIME LINE
= L2
▲▼: select
SAVE?
```

4. Press **SAVE** to accept the setting.

```
PRIME LINE
= L2
Programmed!
```

PROGRAMMING OPTIONS

PROGRAMMING LINE GROUPS / PRIVATE LINE

The 420 system can support up to 12 extensions and 15 lines. This is possible by using line 4 for line groups. This allows additional lines to be shared by extensions. The 420 must be programmed for line groups for the system functions to operate properly. The chart below describes a typical line group application using eight lines.

Department	Line 1	Line 2	Line 3	Line 4	Line 5	Line 6	Line 7	Line 8
Reception	EXT 11	●	●	●	●			
Sales	EXT 12	●	●	●		●		
	EXT 13	●	●	●		●		
	EXT 14	●	●	●		●		
Credit	EXT 15	●	●	●			●	
	EXT 16	●	●	●			●	
	EXT 17	●	●	●			●	
Warehouse	EXT 18	●	●	●		●		
	EXT 19	●	●	●		●		
	EXT 20	●	●	●		●		
Vice President	EXT 21	●	●	●			PRV	
President	EXT 22	●	●	●				PRV

Calls can only be transferred between extensions sharing the same line group. Line 7 and 8 are private and calls cannot be transferred to any other extension.

● = Line Connected PRV = Private Line

The chart below describes a system where all extensions have a private 4th line.

	L1	L2	L3	L4	L5	L6	L7	L8	L9	L10	L11	L12	L13	L14	L15
EXT 11	●	●	●	PRV											
EXT 12	●	●	●		PRV										
EXT 13	●	●	●			PRV									
EXT 14	●	●	●				PRV								
EXT 15	●	●	●					PRV							
EXT 16	●	●	●						PRV						
EXT 17	●	●	●							PRV					
EXT 18	●	●	●								PRV				
EXT 19	●	●	●									PRV			
EXT 20	●	●	●										PRV		
EXT 21	●	●	●											PRV	
EXT 22	●	●	●												PRV

PROGRAMMING OPTIONS

PROGRAMMING LINE GROUPS / PRIVATE LINE (cont.)

- While in the PROGRAM mode, press the ▼ button until the following screen appears:

```
LINE GROUP
▲▼: select
▶: enter
```

- Press the ▶ button to enter.

```
LINE GROUP
= L04
▲▼: select
SAVE?
```

- Use the ▲▼ buttons to change the LINE GROUP.

```
LINE GROUP
= L05
▲▼: select
SAVE?
```

- Press **SAVE** to accept the setting.

```
LINE GROUP
= L05
Programmed!
```

SETTING AUTO-MUTE

When set to ON, the auto-mute feature automatically mutes the microphone of an extension receiving a paging call. Setting this feature to OFF allows the paging party to immediately hear the paged extension. This setting is useful as a ROOM MONITOR and for automatic hands free communication. See PAGING A SINGLE EXTENSION on page 28.

- While in the PROGRAM mode, press the ▼ button until the following screen appears:

```
AUTO-MUTE
▲▼: select
▶: enter
```

- Press the ▶ button to enter.

```
AUTO-MUTE
= On
▲▼: select
SAVE?
```

- Use the ▲▼ buttons to change the setting.

```
AUTO-MUTE
= Off
▲▼: select
SAVE?
```

- Press **SAVE** to accept the setting.

```
AUTO-MUTE
= Off
Programmed!
```

AUTO INTERCOM ANSWER

If auto-mute of one extension is set to OFF and it receives a page from another extension, the page call becomes an automatically answered intercom call.

PROGRAMMING OPTIONS

SETTING TONE/PULSE DIALING

The factory default dialing mode is TONE. If your telephone company requires PULSE dialing, change this setting. If you use pulse dialing it is still possible to access tone services like bank by phone, etc. See TONE/PULSE MIXED DIALING on page 26.

1. While in the PROGRAM mode, press the ▼ button until the following screen appears:

```
TONE/PULSE
▲▼: select
▶: enter
```

2. Press the ▶ button to enter.

```
TONE/PULSE
= Tone
▲▼: select
SAVE?
```

3. Use the ▲▼ buttons to change the setting.

```
TONE/PULSE
= Pulse
▲▼: select
SAVE?
```

4. Press **SAVE** to accept the setting.

```
TONE/PULSE
= Pulse
Programmed!
```

CHANGING THE FLASH DURATION

The default FLASH is set to .6 seconds. This is suitable for most US telephone companies. Older PBX's and international telephone companies might require different timing. If PBX or flash features are not working properly, contact the telephone company or PBX manufacturer to obtain the correct FLASH TIME.

FLASH TIME can be set from .1 seconds to 1.2 seconds in .1 second increments.

1. While in the PROGRAM mode, press the ▼ button until the following screen appears:

```
FLASH TIME
▲▼: select
▶: enter
```

2. Press the ▶ button to enter.

```
FLASH TIME
= 0.6 sec
▲▼: select
SAVE?
```

3. Use the ▲▼ buttons to change the setting.

```
FLASH TIME
= 0.8 sec
▲▼: select
SAVE?
```

4. Press **SAVE** to accept the setting.

```
FLASH TIME
= 0.8 sec
Programmed!
```

PROGRAMMING OPTIONS

CHANGING HOLD REMINDER

The 420 can be set to sound an alert tone when a call has been left on hold for more than 3 minutes. The default setting is HOLD REMINDER = ON.

1. While in the PROGRAM mode, press the ▼ button until the following screen appears:

```
HOLD REMINDER
▲▼: select
▶: enter
```

2. Press the ▶ button to enter.

```
HOLD REMINDER
= On
▲▼: select
SAVE?
```

3. Use the ▲▼ buttons to change the setting.

```
HOLD REMINDER
= Off
▲▼: select
SAVE?
```

4. Press **SAVE** to accept the setting.

```
HOLD REMINDER
= Off
Programmed!
```

PROGRAMMING AREA CODES

The 420 can be programmed with six area codes: 1 "HOME" and 5 "LOCAL". The 420 will use these area codes to determine how to dial Caller ID numbers. LOCAL and HOME area codes will not be dialed when calling a number stored in a Caller ID record.

When numbers are transferred from the Caller ID database to the DIRECTORY (see TRANSFERRING A CALLER ID RECORD TO THE DIRECTORY on page 33) local and home area codes will NOT be transferred to allow correct dialing.

If you must dial your home area code when dialing locally, program "000" as your home area code.

1. While in the PROGRAM mode, press the ▼ button until the following screen appears:

```
AREA CODES
▲▼: select
▶: enter
```

2. Press the ▶ button to enter.

```
HAC
= (empty)
▲▼: select
▶: enter
```

3. Use the numeric keypad to enter your HOME AREA CODE.

```
HAC
= 310
(Enter Digits)
SAVE?
```

4. Press **SAVE** to accept the setting.

```
HAC
= 310
Programmed!
```

5. Repeat for up to 5 LOCAL AREA CODES.

PROGRAMMING OPTIONS

RESETTING THE 420

The 420 can be reset to all factory default settings. The EXTENSION ID NUMBER is reset to 00.

The factory defaults are as follows:

LANGUAGE:	ENGLISH
TIME:	01:01 AM
DATE:	01/01
DAY:	SUNDAY
EXTENSION ID:	00
ALL RINGERS:	ON
L1-L4 RINGERS:	ON
MSGW ON/OFF:	Off, L1-L4
DELAY RING:	OFF
LINE USAGE:	1-4 ON
PRIME LINE:	L1
LINE GROUP:	L04
AUTO MUTE:	ON
TONE/PULSE:	TONE
FLASH TIME:	.6 seconds
HOLD REMINDER:	ON

In addition, all AREA CODES, all CALLER ID RECORDS and all DIRECTORY entries will be deleted.

NOTE:

■ See page 44, Programming Tree, for additional Reset information.

1. While in the PROGRAM mode, press the ▼ button until the following screen appears:

```

RESET ALL
▲▼: select
▶: enter
  
```

2. Press the ▶ button to enter.

```

RESET ALL
ERASE: reset all
  
```

3. Press **ERASE** to RESET.

```

Reset!
  
```

TELEPHONE OPERATION

NEW CALL/MESSAGE WAITING INDICATOR

OFF – There are no Voice Mail messages or new Caller ID records.

ON SOLID – You have new CALLER ID records.

FLASHING - You have new Voice Mail.

VOICE MAIL

If you subscribe to telephone company voice mail, the 420 supports the feature with Visual Message Indication (VMI). When new voice mail is received, the MESSAGE WAITING/NEW CALL indicator will flash and the display will indicate which line has received the new voice mail. When voice mail is reviewed and deleted, the light should automatically turn off.

See the IDLE MODE display in the DISPLAY diagram on page 6.

TURNING THE MESSAGE WAITING INDICATOR ON/OFF

The light and display indication can be turned ON and OFF manually in the PROGRAM MODE.

1. While in the PROGRAM mode, press the ▼ button until the following screen appears:

```

MSGW ON/OFF
▲▼: select
▶: enter
  
```

2. Press the ▶ button to enter.

```

L1 MSGW ON/OFF
▲▼: select
▶: enter
  
```

3. Use the ▲▼ buttons to select the desired line.

4. Press the ▶ button to enter.

```

L1 MSGW ON/OFF
=Off
▲▼: select
SAVE?
  
```

5. Use the ▲▼ buttons to change the setting.

```

L1 MSGW ON/OFF
=Off
▲▼: select
SAVE?
  
```

6. Press **SAVE** to accept the setting.

```

L1 MSGW ON/OFF
=Off
Programmed!
  
```

7. Repeat for the other lines.

OR

1. While in the IDLE mode, press **ERASE**.

The LCD will display:

```

ALL MSGW LIGHT
ERASE: clear?
  
```

2. Press **ERASE** again to turn the indicator off.

```

ALL MSGW LIGHT
Cleared!
  
```

TELEPHONE OPERATION

LINE STATUS INDICATORS

The status of each line is indicated with a LED in the LINE SELECT keys.

Mode	This Extension	Other Extension
Idle	Off	Off
In Use	Irregular Flash	Solid
On Hold	Slow	Regular Flash
Ringing	Fast	Fast
POT in Use	Regular Flash	Regular Flash
Transfer	Slow	Fast

VOLUME CONTROL

Volume levels for each of the three off-hook modes and the telephone ringer can be independently set. Once set, the volume for each mode will be saved until a new setting is entered.

Corded Handset: 4 levels

Speaker: 8 levels

Headset: 4 levels

Ringer: 4 levels

OFF-HOOK VOLUME

1. To change the volume level for each mode, press **VOLUME +** or **VOLUME -** when in that mode.
2. A tone will sound when the highest or lowest setting is reached.

NOTE:

- There is no tone when the highest speaker volume level is reached.

RINGER VOLUME

1. From the idle mode, press **VOLUME +** or **VOLUME -** until the desired ringer level is heard.

TELEPHONE OPERATION

MAKING TELEPHONE CALLS

Incoming and outgoing calls can be made using the handset, headset or speakerphone modes. Switch between off-hook modes as follows:

Handset to headset – press **HEADSET**.

Handset to speakerphone – press **SPEAKER**.

Headset to handset – lift the handset.

Headset to speakerphone – press **SPEAKER**.

Speakerphone to handset – lift the handset.

Speakerphone to headset – press **HEADSET**.

PRIME LINE

When a line is set as the PRIME LINE, the 420 will attempt to seize this line when the phone is taken off-hook. If the PRIME LINE is not available when the phone goes off hook, the next available line will be selected. If all lines are in use, an error tone will be heard and no line will be seized.

The PRIME LINE selection can be overridden simply by pressing the **LINE SELECT** button. If the line selected is free, the speakerphone will be automatically activated. If the line is in use, the line will not be seized.

RECEIVING TELEPHONE CALLS

A call can be manually answered by pressing the **LINE SELECT** button for the ringing line. The speakerphone will turn ON and the call will be answered.

If the phone is ringing and is taken off-hook without selecting a line, the ringing line will be answered. If more than one line is ringing, the calls will be answered in the order of the lines, one through four.

If the phone is ringing and you do NOT wish to answer the call but wish to make an outgoing call, press the **LINE SELECT** button of a non-ringing line.

RECEIVING CALL WAITING CALLS

If you subscribe to Call Waiting and a call is received on a line in use for another call, you will hear a beep to indicate the presence of a Call Waiting call. If you subscribe to Call Waiting Caller ID, the Caller ID information will appear on the display.

To answer the call waiting call, either press **FLASH** or enter the CENTREX call waiting command (for example *99) on the desk station. To simplify CENTREX operation, you can program the command into one of the feature keys. Refer to your CENTREX manual for the correct command sequence.

TELEPHONE OPERATION

TRANSFERRING CALLS

Calls answered at one extension can be transferred to any available extension in the system.

TO TRANSFER A CALL

1. While off-hook, press **TRANSFER** followed by the extension to which the call is to be transferred.

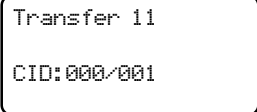

Transfer 11
CID:000/001

2. The call will automatically be placed on hold at the transferring extension.
3. Hang up.

NOTES:

- If a call is transferred and not answered by the intended recipient, an alert tone will sound every 3 minutes (Hold Reminder is programmed ON). After 20 minutes without being answered, the call will automatically be dropped.
- If an extension number is not entered within 10 seconds, the call will remain on hold and the display will return to idle mode.

ANSWER A TRANSFERRED CALL

The extension receiving the transferred call will sound a fast ring. The line indicator for the transferred call will flash rapidly to inform the call recipient which line to pick up.

1. If your phone rings the distinctive transfer ring, simply go off-hook to take the call.

NOTE:

- Any extension can answer a transferred call by simply pressing the line select button for the call being transferred.
- If DND is activated at the extension to which a call is transferred, the recipient will not be disturbed and the call will not be transferred.

HOLD

Places the current call on HOLD. Both parties cannot hear each other when HOLD is engaged.

TO PLACE A CALL ON HOLD

1. Press **HOLD**.
2. The **LINE INDICATOR** will flash (regular) to indicate that the call is on Hold.

TO RELEASE A CALL ON HOLD

1. Press the flashing **LINE** button or pick up another phone on the same line.
2. The call will be released from hold.

Any 420 extension in a system can take a call off-hold.

NOTES:

- If the Hold Reminder is programmed ON, an audible reminder will alert you that the call has been left on hold for more than 3 minutes.
- If a call has been on hold for more than 20 minutes, the unit will automatically disconnect the call.

TELEPHONE OPERATION

MUTE

Disables the microphone on the 420 handset, headset and speakerphone. This is useful for private conversations in the middle of a call.

TO MUTE A CALL

1. Press **MUTE**.
2. The **MUTE INDICATOR** will light to indicate that the 420 has been muted.

TO RELEASE MUTE

1. Press **MUTE**.
2. Mute is released and the call can be resumed.

FLASH/FEATURE

Used to answer a call waiting call or to activate a telephone company feature. The **FLASH** command can be programmed into the one-touch **FEATURE KEYS** and the **DIRECTORY** dialing sequences.

REDIAL/LAST NUMBER REDIAL

Automatically dials the last number called, up to 32 digits in length.

1. Press **REDIAL**.
 2. The 420 will automatically go off-hook using the speakerphone.
- OR
1. Go off-hook manually.
 2. Press **REDIAL**.

The number stored in the Last Number Redial memory can be transferred to the Directory (see page 34) or a Feature Key (see page 36).

AUTO REDIAL

The 420 can automatically redial a busy number. It will make 10 attempts at 30 second intervals.

1. Press **REDIAL/AUTO REDIAL** twice within 3 seconds. The **AUTO REDIAL LED** will flash and the speakerphone will go off-hook on the prime line (if available). The **MUTE** light comes on.
2. To end the Auto Redial and talk to the party you are calling, press **SPEAKER, HEADSET** or lift the handset.

NOTE:

- The LED will flash slowly between dialing attempts and rapidly during the actual dialing to alert you that the Auto Redial mode is active.

TELEPHONE OPERATION

3-WAY CALL CONFERENCING

The 420 allows you to bridge a call between any two lines to establish a 3-way conference call.

1. Initiate the first call.
2. Place the first call on **HOLD**.
3. Initiate the second call.
4. Press **CONFERENCE**. You will now be talking to parties on both lines.
5. To end the conference call simply hang-up.

NOTE:

- In some instances where the two parties joined by the 420 are a long distance away from their telephone company's central office, these two far end parties might not hear each other very well. If this occurs frequently, it is recommended that the telephone company's 3-way calling service be used.*
 - Call Waiting Caller ID records will not be displayed or logged during a 3-Way Conference Call.
- *Subscription to 3-way calling service is required.

TONE/PULSE MIXED DIALING

This feature is useful if your telephone service is PULSE and you need to use TONE dialing to access a special service. This feature is only needed if you have programmed the TONE/PULSE setting to PULSE mode.

1. Dial the telephone number and wait for the line to connect.
2. Press *** TONE** on the key pad to temporarily change from PULSE dialing to TONE dialing.
3. Dial the tone numbers (such as automated menu choices).
4. Hang up and the 420 automatically returns to the PULSE mode.

DND – DO NOT DISTURB

When DND is activated, the 420 will not ring for an intercom, transferred or regular telephone call. Likewise, the paging feature will also be muted allowing you to work undisturbed.

TO ACTIVATE DND

1. Press **DND** to activate the feature.
2. The DND LED will light on the button and **DND** will appear in place of **EXT** on the LCD, indicating that the feature is ON.

When another extension attempts to intercom or page an extension on which DND is active, the calling party will hear a fast busy tone.

TO DEACTIVATE DND

1. Simply press **DND**. The LED will turn off and the telephone will ring and be available to intercom or page an extension.

TELEPHONE OPERATION

CALL PRIVACY – EXTENSION CONFERENCING

Calls on any 420 extensions are private. Other 420 extensions cannot intrude on the call unless the extension user releases privacy.

TO DEACTIVATE CALL PRIVACY (ALLOWING OTHERS TO JOIN CALL)

1. While on a call, press the **LINE SELECT** key. A beep will sound indicating that privacy is released.
2. The LINE STATUS LED for the released privacy call will remain lit on the other extensions, allowing others to join the call by simply pressing the **LINE SELECT** key.

TO RESTORE CALL PRIVACY

1. Press the **LINE SELECT** key. A double beep will sound, indicating that privacy is restored.
2. Any joined extensions will be dropped and the call will again be private.

Calls in progress on non-420 telephones common lines are not private and can be joined at any time by a 420 extension.

PAGING AND INTERCOM

The PAGING and INTERCOM features require that LINE 1 be common to all 420's in the system.

NOTE:

- Only one paging or intercom call can be supported at one time. When the paging/intercom system is in use the INTERCOM indicator will light on all extensions in the system.

PAGING ALL EXTENSIONS

All extensions can be paged simultaneously by any 420 in the system.

1. Press **PAGE ALL**. The INTERCOM and SPEAKERPHONE indicators will light.
2. Lift the handset, activate the headset or simply speak into the built in speakerphone microphone.
3. To end the page, hang-up the phone by pressing **SPEAKER**, **HEADSET** or return the handset to the cradle.

ANSWERING A SYSTEM WIDE PAGE

When extension 12 initiates a system wide page, every idle 420 in the system will have the following display:

PAGE ALL BY 12

CID:000/001

TELEPHONE OPERATION

ANSWERING A SYSTEM WIDE PAGE (cont.)

Any 420 in the system can answer the page and talk to the paging station.

1. Press **PAGE** to answer. You can use the speakerphone, headset or handset to converse.
2. To end, simply hang-up.

NOTE:

- Only one extension can answer a system wide page at a time.

PAGING A SINGLE EXTENSION

1. Extension 22 presses **PAGE**, then enters "11" to page extension 11.
2. Extension 11 receives the page:

PAGE 11
CID: 000/001

PAGE 22
CID: 000/001

ANSWERING A SINGLE EXTENSION PAGE

AUTO-MUTE OFF AT RECEIVING EXTENSION

When an extension receives a page, the phone will beep and the speakerphone will automatically be activated. You can begin speaking or switch to the handset or headset.

AUTO-MUTE ON AT RECEIVING EXTENSION

When an extension receives a page, the phone will beep and the speakerphone will be activated and the MUTE indicator will light. To answer the page, press **MUTE** and begin speaking. The handset or headset can also be used.

NOTE:

- If a paged extension is in use or DND is on, the paging station will hear a busy tone.

ROOM MONITOR

The paging feature can be used as a room monitor.

1. Press **PAGE** followed by the extension number to be monitored.
2. Activate **MUTE** by pressing **MUTE** so sounds on the monitoring side are not broadcasted.
3. To end the monitoring, press **SPEAKER**.

NOTE:

- An extension cannot be monitored if the AUTO-MUTE feature is set to ON at that extension.

TELEPHONE OPERATION

MAKING AN INTERCOM CALL

1. Press **INTERCOM** followed by the number of the extension you wish to call.

ICM 22
CID: 000/001

2. The extension you called will hear the intercom ring and the display will indicate which extension is calling.

ICM 11
CID: 000/001

NOTE:

- If the extension being called is in use or DND is ON, a busy ring will be heard.

ANSWERING AN INTERCOM CALL

1. Press **INTERCOM**. The speakerphone will activate and you can begin speaking. The handset or headset can also be used.
2. To end the call, simply hang-up.

MAKING AN INTERCOM CONFERENCE CALL

1. Make or answer a telephone call.
2. Press **INTERCOM** and enter the number of the extension with which you want to conference.
3. When the extension answers, press **CONFERENCE** to join all parties.

NOTE:

- An intercom conference call cannot be placed on hold.

CALLER ID

Caller ID is a subscription service available from your telephone service provider and is required for the Caller ID features to operate.

To receive Caller ID information for a Call Waiting call, you must subscribe to the combined Call Waiting Caller ID service from your telephone service provider. Even if you subscribe to both Caller ID and Call Waiting services separately, it is possible that you are not subscribed to the combined service.

The 420 will store and display on demand the 200 most recent caller ID records.

THE CALLER ID DISPLAY

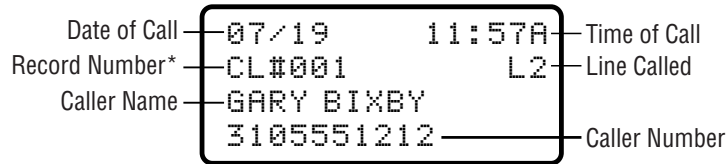

VIEWING CALLER ID INFORMATION

VIEWING CALLER ID INFORMATION OF AN INCOMING CALL

During an incoming call, the name and telephone number of the caller (if available) will display on the LCD. The information is received by the 420 between the first and second ring.

NOTE:

- If you answer a call before the second ring, the Caller ID information might not be displayed.
- Call Waiting Caller ID records will not be displayed or logged during a 3-Way Conference Call.

VIEWING CALLER ID INFORMATION OF SIMULTANEOUS INCOMING CALLS

When multiple lines are ringing, you can view the Caller ID information for each line by pressing **CALLER** to toggle the display between the Caller ID information for each ringing line.

CALL WAITING CALLER ID

If you subscribe to Call Waiting Caller ID (combined service), the 420 will display the Caller ID information (if available) from the Call Waiting calls. During a phone call, you will hear a beep to indicate the presence of a Call Waiting call. Shortly afterward, the Caller ID information will appear on the LCD.

To answer the call waiting call, either press **FLASH** or enter the CENTREX call waiting command (for example *99) on the desk station. To simplify CENTREX operation, you can program the command into one of the feature keys. Refer to your CENTREX manual for the correct command sequence.

If you do not answer the call, the calling party will hear the phone continue to ring. If you subscribe to voice mail, the incoming call will be answered by voice mail.

CALLER ID

STORED CALLER ID RECORDS

The 420 will store the 200 most recent Caller ID records. Caller ID records are numbered sequentially in the order in which they are received. When the memory is full, the oldest record will be deleted automatically each time a new record is received.

VIEWING STORED CALLER ID RECORDS

1. Press **CALLER ID** to enter the Caller ID database. The LCD will display the number of CID records.



2. Use the **▲▼** buttons to scroll through the stored caller ID records.
3. Press **END** to exit, or wait 20 seconds and the LCD will revert back to the IDLE MODE.

INFORMATION OTHER THAN THE CALLER'S NAME AND NUMBER MAY BE DISPLAYED

Display	Meaning
Private Name	The other party is blocking name information
Private Number	The other party is blocking telephone number information
Out Of Area	Your phone company is unable to receive this caller's name or number
Incomplete DATA	Line disturbance occurred during transmission

DIALING USING CALLER ID RECORDS

In addition to storing and displaying up to 200 Caller ID records, phone numbers contained in those Caller ID records can be automatically dialed.

If you have programmed local and home area codes, any numbers from within those area codes will be dialed WITHOUT the initial "1" and area code.

1. Select the desired Caller ID record.
2. Press **DIAL**.
3. The 420 will automatically go off-hook and speakerphone dialing will commence automatically. The handset or the headset may be used to continue the call.

OR

1. Manually go off-hook.
2. Press **DIAL**.

CALLER ID

DELETING CALLER ID RECORDS

DELETING AN INDIVIDUAL CALLER ID RECORD

1. Press **CALLER ID**.
2. Locate the desired Caller ID record using the **▲▼** buttons.
3. Press **ERASE**.
4. The screen will prompt **ERASE: erase?**
5. Press **ERASE** to confirm or **END** to abort.

DELETING ALL CALLER ID RECORDS

1. Press **CALLER ID**.
2. Immediately press **ERASE** without scrolling through the individual records.
3. The screen will prompt **ERASE :all?**
4. Press **ERASE** to confirm or **END** to abort.

DIRECTORY

The 420 will store up to 200 names and numbers in an alphabetical phone directory. You may manually program each Directory record or you may transfer a Caller ID record into the Directory.

CREATING A NEW DIRECTORY ENTRY

The maximum name length is 16 characters. The maximum number length is 32 digits.

1. Press **DIRECTORY**.
2. Press **SAVE**.

```
(Enter name)
SAVE: save?
```

3. Press the appropriate keypad key to toggle through the letters and numbers associated with that key (For example: press the number "5" key to toggle among the letters "J", "K" and "L", and the number "5").
4. When the desired letter appears, press the **▶** button to manually move to the next character. Pressing the **▶** button twice will insert a space.

5. Press **SAVE** when the name is complete.

```
GARY BIXBY
(Enter Number)
SAVE: save?
```

6. Enter the telephone number using the numeric keypad.
7. Press **SAVE** when done.

```
GARY BIXBY
5551212
Saved!
```

NOTE:

- If you make a mistake while entering a name or number, use the **◀** button to backspace and erase.

To add a PAUSE or a FLASH to a Directory dialing sequence press the appropriate button while entering a telephone number. The letter "P" will be displayed to indicate a PAUSE and "F" a FLASH.

DIRECTORY

TRANSFERRING A CALLER ID RECORD TO THE DIRECTORY

The 420 allows Caller ID records to be transferred to the directory.

1. Display the desired Caller ID record.

```
11/12 10:27A
CL#002
GARY BIXBY
5551212
```

2. Press **END** to exit the CALLER ID mode.
3. Press **DIRECTORY**.
4. Press **SAVE** as if to add a new entry.

```
(Enter name)
SAVE: save?
```

5. Press **CALLER ID** to copy the last viewed Caller ID record into the DIRECTORY.

6. A new Directory record will be created automatically, using the name and number of the Caller ID record.

```
GARY BIXBY
5551212
SAVE: save?
```

If you wish to edit the new Directory record, use the **◀** button to backspace.

7. Press **SAVE** when done.

```
GARY BIXBY
5551212
Saved!
```

LOCATING A DIRECTORY RECORD

TO SCROLL THROUGH THE ALPHABETICAL LIST OF DIRECTORY RECORDS

1. From idle mode press **DIRECTORY**.
2. Use the **▲▼** buttons to scroll through the DIRECTORY entries.

LOCATING A DIRECTORY RECORD (BY JUMPING)

To jump immediately to the Directory listings beginning with a selected letter:

1. Press **DIRECTORY**.
2. Press the keypad key associated with the desired letter and continue pressing the key until the desired letter is displayed.
3. The display will jump to the first Directory listing beginning with the chosen letter.

DIALING A DIRECTORY NUMBER

1. Select the desired Directory record.
2. Press **DIAL**. The telephone will automatically go into speakerphone mode and dialing will commence automatically. The handset or the headset may be used to continue the call.

DIRECTORY

DELETING DIRECTORY RECORDS

DELETING AN INDIVIDUAL DIRECTORY RECORD

1. Press **DIRECTORY**.
2. Locate the desired record using the ▲▼ buttons or by jumping.
3. Press **ERASE**.
4. The screen will prompt ERASE: erase?
5. Press **ERASE** to confirm or **END** to abort.

DELETING ALL DIRECTORY RECORDS

1. Press **DIRECTORY**.
2. Immediately press **ERASE** without scrolling through the individual records.
3. The screen will prompt ERASE: all?
4. Press **ERASE** to confirm or **END** to abort.

TRANSFERRING A NUMBER FROM LNR (LAST NUMBER REDIAL) TO THE DIRECTORY

The 420 allows the number stored in the Last Number Redial memory to be transferred to the Directory.

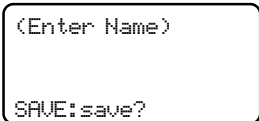
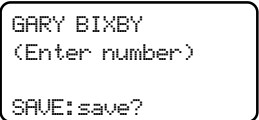
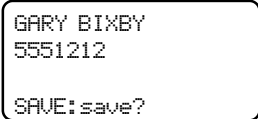
1. Press **DIRECTORY**.

2. Press **SAVE** to enter the Program mode.

3. Enter the name, then press **SAVE** to proceed.

4. Press **REDIAL** to copy the phone number from the LNR. A confirmation tone will sound.

5. Edit the phone number if you wish, then press **SAVE** to finish.

ADDITIONAL FEATURES

PROGRAMMING THE FEATURE KEYS

Ten FEATURE keys can store twenty names and phone numbers or commonly used CENTREX or other telephone company features. These one touch dial locations can be programmed and dialed by pressing the desired FEATURE key and/or SHIFT key.

Maximum capacities: name - 16 characters; number - 32 digits.

Write the information you want to store on the FEATURE key index card before you perform the programming steps below.

1. Press the desired **FEATURE** key. If you are programming the “second” memory locations, press **SHIFT** followed by the **FEATURE** key.
4. When the desired letter appears, press the ► button to manually move to the next character. Pressing the ► button twice will insert a space.

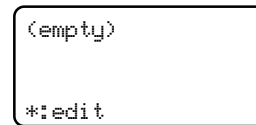

NOTE:

- If the **FEATURE** key is not empty, press **ERASE** twice to delete the existing name and number.
2. Press the “*” key to begin entering the name.

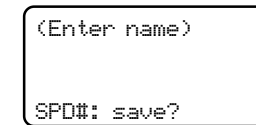

3. Press the appropriate keypad key to toggle through the letters and numbers associated with that key (For example-press the number “5” key to toggle among the letters “J”, “K” and “L”, and the number “5”).

5. Press **SAVE** when the name is complete.

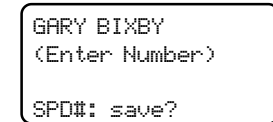

6. Enter the telephone number using the numeric keypad.

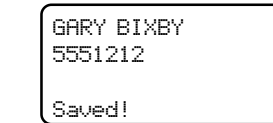

7. Press the **FEATURE** key again when done. If you are programming the “second” memory, press **SHIFT** followed by the **FEATURE** key to finish.

8. A confirmation ring will sound.

NOTE:

- If you make a mistake while entering a name or number, use the ◀ button to backspace and erase.

DIALING USING THE FEATURE KEYS

1. Go off hook.
2. Press the desired **FEATURE** key. To dial the “second” memory, press **SHIFT** followed by the **FEATURE** key.

ADDITIONAL FEATURES

TRANSFERRING A NUMBER FROM LNR (LAST NUMBER REDIAL) TO A FEATURE KEY

The 420 allows the number stored in the Last Number Redial memory to be transferred to a FEATURE key.

1. Follow steps 1-2 under “PROGRAMMING THE FEATURE KEYS” on page 35.
2. Press **SAVE** to save the name.

```
GARY BIXBY  
(Enter number)  
SPD#:save?
```

3. Press **REDIAL** to copy the phone number from the LNR to the LCD.

```
GARY BIXBY  
5551212  
spd#:save?
```

4. Edit the phone number if you wish, then press the **FEATURE** key to save the name and number into that location.

USING A HEADSET

If you wish to connect a headset to the 420, we recommend the Plantronics family of products, for which the 420 has been optimized. These headsets can be purchased from your telephone company, your local electronics retailer or from Plantronics directly. Specify a RJ-22 headset connector when ordering.

A dedicated HEADSET button on the 420 allows you to keep the headset plugged in, and to only use it when desired.

Plantronics is a registered trademark of Plantronics, Inc.

POWER FAILURE OPERATION

Incoming calls can be received (the phone will ring) and outgoing calls can be made on all four lines using the handset or headset. An optional 9 volt battery must be installed for power failure operation. The speakerphone will not function during a power failure.

The Caller ID database and the Directory database are stored in non-volatile memory and will not be affected during a power failure. During a power failure, the Directory and Program Modes will not operate. New Caller ID data transmitted during a power failure will not be displayed or stored.

BATTERY LOW INDICATION

When the back-up battery becomes old or weak, the word **BATT** will appear on the display.

```
09/06 08:41A  
EXT 22  
CID:000/001 BATT
```

Replace the battery as described in **INSTALLING THE BATTERY** on page 6.

NOTE:

- Use only ALKALINE batteries.

TROUBLESHOOTING

During Initial Set-up, the Phone Beeps Continuously

- Make sure that each 420 in the system is assigned a unique EXTENSION NUMBER between 11 and 22.

Intercom, Page All, Privacy and/or other system features do not work properly.

- DSL service can interfere with communication between Executive Series telephones. Usage should be restricted to Line 3 or 4 and a filter (provided by the DSL provider) should be installed.
- Make sure the total length of wiring used in your system is less than 600 feet. If the wiring is longer, you may need to use a special filter device. Contact the company from which you purchased the phone to obtain this filter.
- Installation sites at greater distances from the telephone company central office may also experience network communication problems. These problems include inability to make or receive intercom calls or inconsistent call transfers and paging. If you are experiencing these problems, a filter (part number 3001-01) needs to be installed. Contact the company from which you purchased the phone to obtain this filter.

Cannot Access Program Mode

- Is the extension off-hook? You cannot program the phone and talk on it at the same time.

Telephone Does Not Ring

- Make sure the Do Not Disturb (DND) feature is not activated.
- Make sure ringers are turned on.
- If there are several non-system phones on the line that do not ring, disconnect some of them.
- If the INTERCOM light flashes but you do not hear a paging signal, make sure the Do Not Disturb (DND) feature is not activated.
- If you subscribe to Telephone Company Voice Mail, make sure the Delay Ring setting is not greater than the time it takes for Voice Mail to answer. See pg. 13.

Telephone Handset is Dead

- Make sure the coiled handset cord is plugged into the HANDSET jack, not the HEADSET jack. See pg. 7.

Intercom Paging Signal Not Received

- Make sure you have programmed your extension number correctly. Line 1 must be connected at all extensions and must be the same telephone number/line for Page and Intercom to work properly.
- Make sure the Do Not Disturb feature is turned off at the extension you are calling.

Cannot Join a Conversation in Progress

- The PRIVACY feature prevents another extension on the system from interrupting a conversation. Press the **LINE** button to release privacy.

TROUBLESHOOTING

Error Tone (Fast Busy Signal) Heard When Making an Intercom Call

- The Do Not Disturb feature is activated at the extension you are calling.

Line Lights Remain On When No Line is Connected

- Make sure the system is programmed for that line to be off. (See “Programming the Line Usage” in PROGRAMMING OPTIONS.) See pg. 14.
- Make sure that your Line Groups are programmed properly. (See “Programming Line Groups/Private Line” in PROGRAMMING OPTIONS.) See pg. 16.
- Disconnect all other devices (fax, modem, credit card reader, etc.) from any lines connected to your phone. These devices can interfere with the system’s data links.

Operation During a Power Failure

- A 9-volt battery must be installed for power failure operation. See pg. 36.

No Call Waiting Caller ID Information While on a Call

- You must subscribe to **combined** Caller ID with Call Waiting as a single service to see Call Waiting information.
- Call Waiting Caller ID records will not be displayed or logged during a 3-Way Conference Call.

Display Screen is Blank

- Make sure the power cord is connected to both the phone and an electrical outlet that is not controlled by a wall switch.
- Verify that the AC outlet is working by plugging a lamp, etc. to test.

No Caller ID Information Received

- Subscription to Caller ID service is required.
- Caller ID information is transmitted by the telephone between the first and second rings. If you answer a call before the second ring, the Caller ID information may not be displayed.
- Call Waiting Caller ID records will not be displayed or logged during a 3-Way Conference Call.

MESSAGE WAITING/NEW CALL Light Flashes

- Make sure you have deleted all messages on all lines.
- It may be a false indicator from the Central Office. To clear, see “Turning the Message Waiting Indicator On/Off” in ADDITIONAL FEATURES.

PROGRAMMING TREE

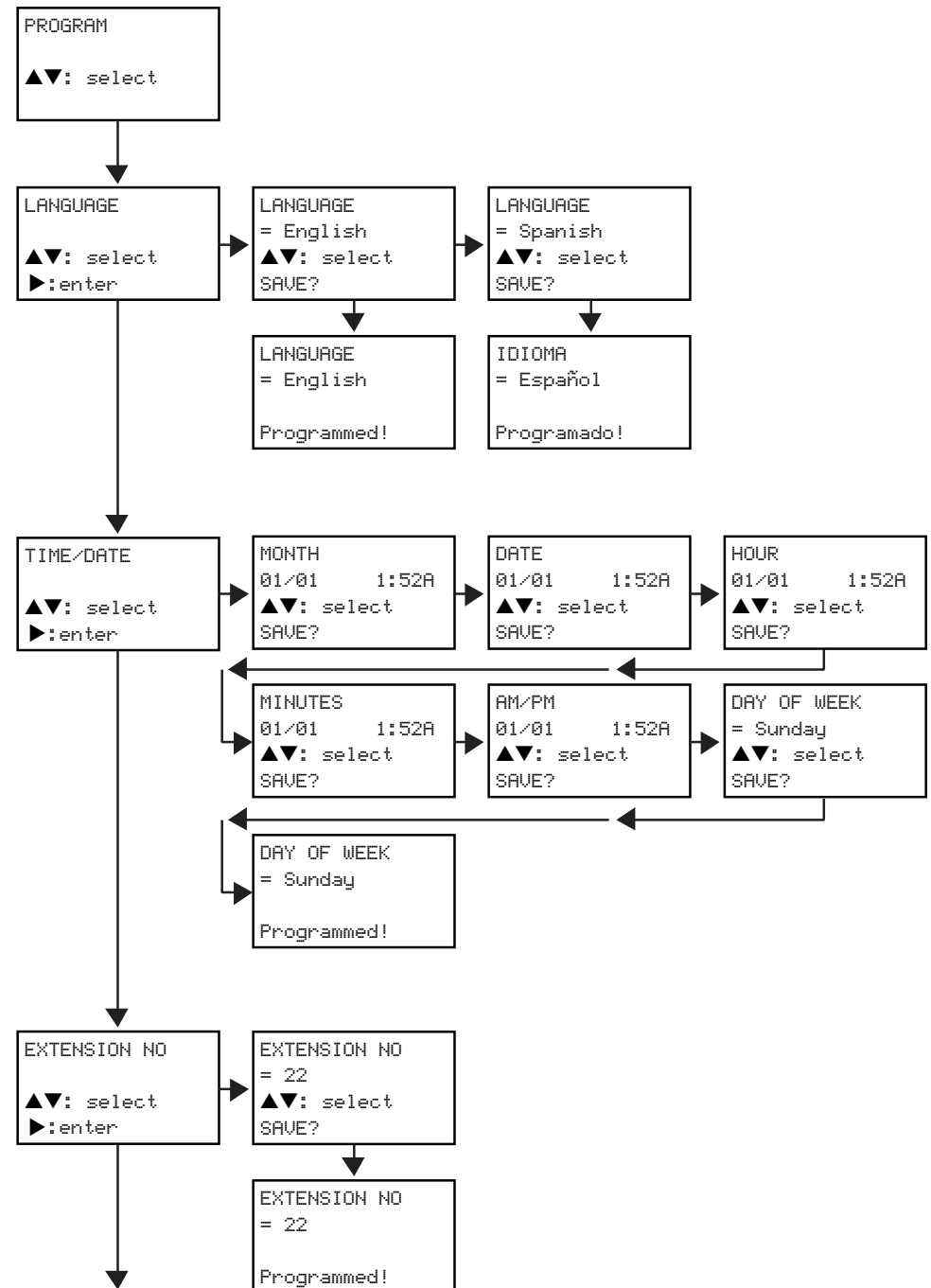

PROGRAMMING TREE

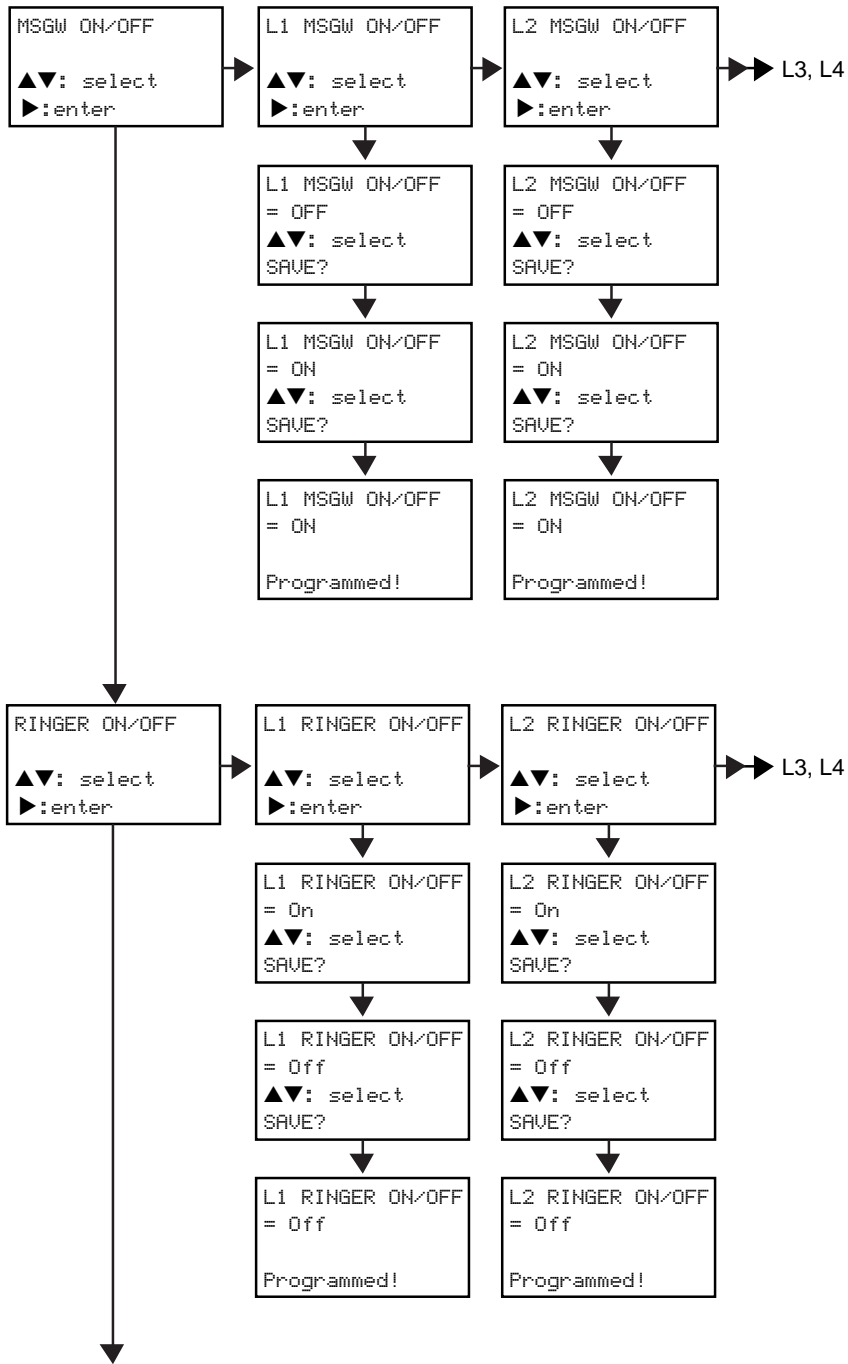

PROGRAMMING TREE

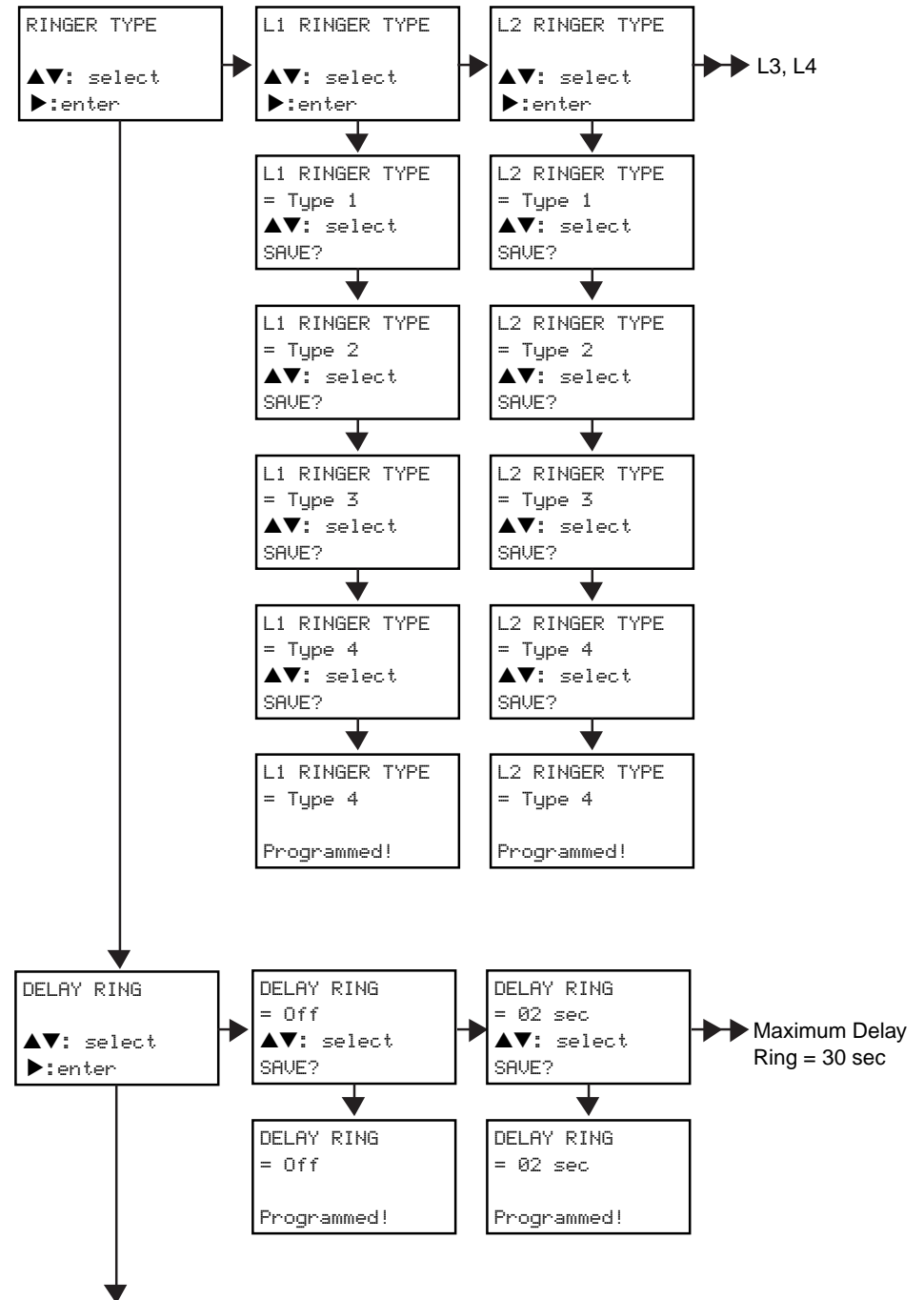

ADDITIONAL

ADDITIONAL

PROGRAMMING TREE

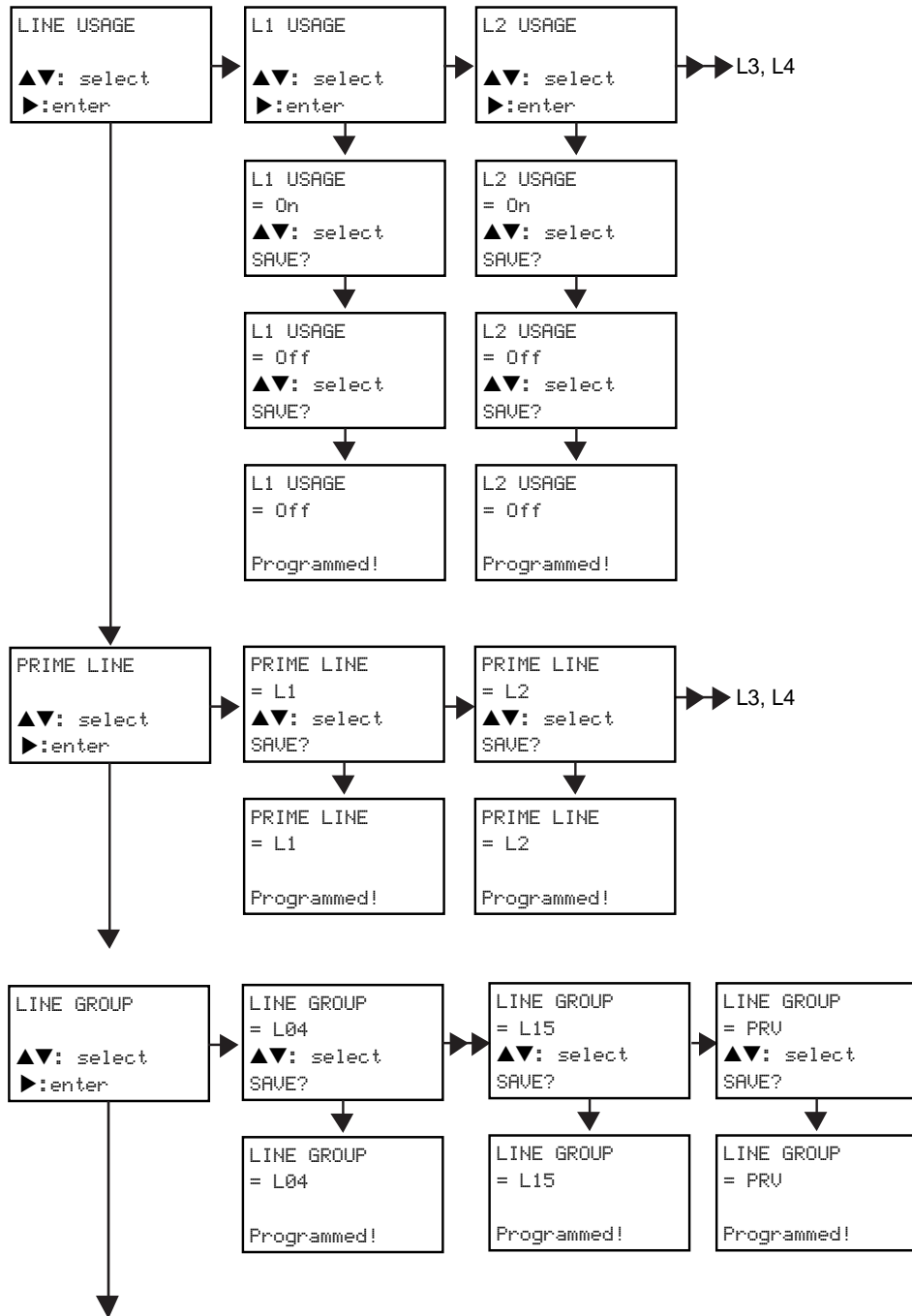

PROGRAMMING TREE

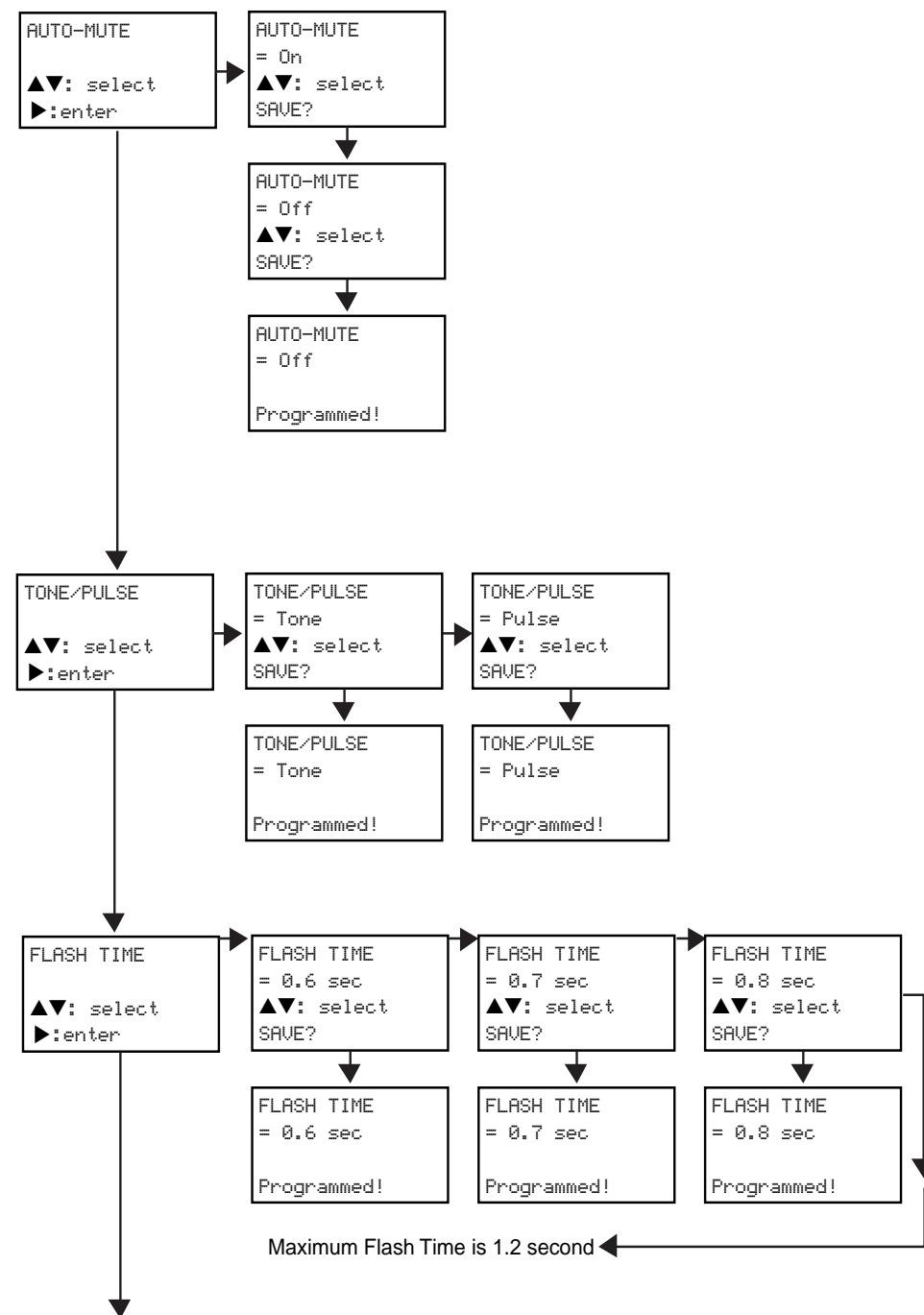

ADDITIONAL

ADDITIONAL

PROGRAMMING TREE

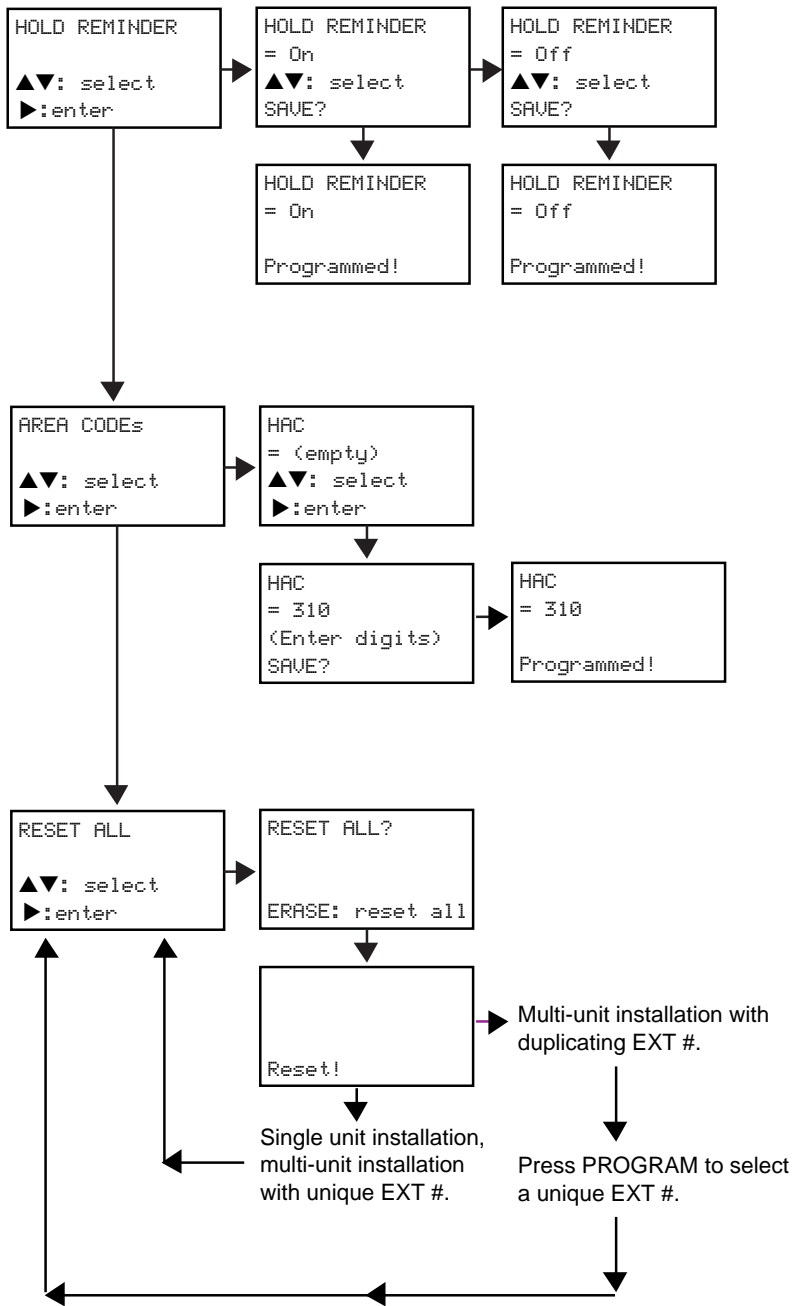

FCC REQUIREMENTS

USER INSTRUCTIONS

1. This equipment complies with Part 68 of the FCC rules. On the bottom of this equipment is a label that contains, among other information, the FCC registration number and Ringer Equivalence Number (REN) for this equipment. If requested, provide this information to your telephone company.
2. The REN is useful to determine the quantity of devices you may connect to your telephone line and still have all of those devices ring when your number is called. In most, but not all areas, the sum of the RENs of all devices should not exceed five (5.0). To be certain of the number of devices you may connect to your line, as determined by the REN, you should call your local telephone company to determine the maximum REN for your calling area.
3. If your telephone causes harm to the telephone network, the telephone company may discontinue your service temporarily. If possible, they will notify you in advance. But if advance notice is not practical, you will be notified as soon as possible. You will be advised of your right to file a complaint with the FCC.
4. Your telephone company may make changes in its facilities, equipment, operations, or procedures that could affect the proper operation of your equipment. If they do, you will be given advance notice so as to give you an opportunity to maintain uninterrupted service.
5. If there is a problem with this unit, the telephone company may ask you to disconnect this equipment from the network until the problem has been corrected or you are sure that the equipment is not malfunctioning.
6. Repairs can only be made by the manufacturer or an authorized service agency. Unauthorized repairs void registration and warranty. Contact seller or manufacturer for details of permissible user-performed routine repairs, and where and how to have other than routine repairs made.
7. This equipment may not be used on coin service provided by the telephone company. Connection to party lines is subject to state tariffs. (Contact your state public utility commission or corporation commission for information.)

Jacks: USOC RJ61, RJ14, 2X RJ-11 Ringer Equivalence: See bottom/underside of the base unit.

NOTE: This equipment has been tested and found to comply with the limits for a Class B digital device, pursuant to Part 15 of the FCC Rules. These limits are designed to provide reasonable protection against harmful interference in a residential installation. This equipment generates, uses, and can radiate radio frequency energy and, if not installed and used in accordance with the instructions, may cause harmful interference to radio communications. However, there is no guarantee that interference will not occur in a particular installation. If this equipment does cause harmful interference to radio or television reception, which can be determined by turning the equipment off and on, the user is encouraged to try to correct the interference by one or more of the following measures:

- Reorient or relocate the receiving antenna.
- Increase the separation between the equipment and receiver.
- Connect the equipment into an outlet on a circuit different from that to which the receiver is connected.
- Consult the dealer or an experienced radio/TV technician for help.

Any changes made by the user not approved by the manufacturer can void the user's authority to operate the equipment. **This product is hearing aid compatible.**

OWNER'S GUIDE

Technical Specifications

FCC Registration No.:

See bottom/underside of the unit

Power Source:

Base Unit, Adapter M/N-140
Output: 12VDC 400mA

Ringer Equivalence:

See bottom/underside of the unit

Battery Type: 9 Volt

Lines: 4 Analog/POTS

Handset Amplification: 0dB to +12dB, 4 levels

Jacks:

RJ61 USOC = L1/L2/L3/L4

RJ14=L3/L4

2XRJ11=L3/L4

Headset Jack: RJ22

The unit is hearing aid compatible.

Design and specifications are subject to change without notice.

Feature Specifications

Caller ID with Call Waiting: Type 2

Message Waiting Indicator: FSK

Feature Keys (Autodialers/Centrex):

20 @ 32 digits

Directory Records: 200 @ 32 digits

Caller ID Records: 200

LCD: English/Spanish, 4 lines x 16 characters

Speakerphone: Half Duplex

3-way Conference

Clock/Call Timer

Tone/Pulse

Mixed Tone/Pulse Dialing

Flash: 600ms/100ms-1200ms

Distinctive Ring Compatible

Non KSU Features:

Intercom

Paging

Call Transfer

Networking Requirements:

Common Line 1

600 feet, maximum



UZ634ZT

420 M1S1 10/12/01

Printed in Taiwan

IMPORTANT SAFETY INSTRUCTIONS

INSTALLATION INSTRUCTIONS

1. Never install telephone wiring during a lightning storm.
2. Never install telephone jacks in wet locations unless the jack is specifically designed for wet locations.
3. Never touch uninsulated telephone wires or terminals unless the telephone line has been disconnected at the network interface.
4. Use caution when installing or modifying telephone lines.

SAFETY PRECAUTIONS

When using your telephone equipment, basic safety precautions should always be followed to reduce the risk of fire, electric shock and injury to persons, including the following:

1. Read and understand all instructions.
2. Follow all warnings and instructions marked on the product.
3. Unplug this product from the wall outlet before cleaning. Do not use liquid cleaners or aerosol cleaners. Use a damp cloth for cleaning.
4. Do not use this product near water: for example, near a bath tub, wash bowl, kitchen sink or laundry tub, in a wet basement, or near a swimming pool.
5. Do not place this product on an unstable cart, stand, or table. The product may fall, causing serious product damage.
6. Slots and openings in the cabinet and the back or bottom are provided for ventilation. To protect it from overheating, these openings must not be blocked or covered by placing the product on the bed, sofa, rug, or other similar surface. This product should never be placed near or over a radiator or heat register. This product should not be placed in an enclosed environment unless proper ventilation is provided.
7. Do not allow anything to rest on the power cord. Do not locate this product where the cord will be abused by animals or persons walking on it.
8. Do not overload wall outlets and extension cords as this can result in the risk of fire or electric shock.
9. Never push objects of any kind into this product through cabinet slots as they may touch dangerous voltage points or short out parts that could result in a risk of fire or electric shock.
10. Never spill liquid of any kind on the product.
11. To reduce the risk of electric shock, do not disassemble this product. Take it to a qualified serviceperson when service or repair work is required. Opening or removing covers may expose you to dangerous voltages or other risks. Incorrect re-assembly can cause electric shock when the appliance is subsequently used.
12. Unplug this product from the wall outlet and refer servicing to qualified service personnel under the following conditions:
 - A. When the power supply cord or plug is damaged or frayed.
 - B. If liquid has been spilled into the product.
 - C. If the product has been exposed to rain or water.
 - D. If the product does not operate normally by following the operating instructions. Adjust only those controls that are covered by the operating instructions because improper adjustment of other controls may result in damage and will often require extensive work by a qualified technician to restore the product to normal operation.
 - E. If the product has been dropped or the cabinet has been damaged.
 - F. If the product exhibits a distinct change in performance.
13. Avoid using a telephone (other than a cordless type) during an electrical storm. There may be a remote risk of electric shock from lightning.
14. Do not use the telephone to report a gas leak while near the leak.
15. You should use ONLY the power adapter supplied with your telephone.

SAVE THESE INSTRUCTIONS

Technical Specifications

FCC Registration No.:	Power Source:
See bottom/underside of the unit	Base Unit, Adapter M/N-140 Output: 12VDC 400mA
Ringer Equivalence:	Battery Type: 9 Volt
See bottom/underside of the unit	
Lines: 4 Analog/POTS	Handset Amplification: 0dB to +12dB, 4 levels
Jacks:	The unit is hearing aid compatible.
RJ61USOC = L1/L2/L3/L4	Design and specifications are subject to change without notice.
RJ14=L3/L4	
2XRJ11=L3/L4	
Headset Jack: RJ22	

Feature Specifications

Caller ID with Call Waiting: Type 2	Non KSU Features:
Message Waiting Indicator: FSK	Intercom
Feature Keys (Autodialers/Centrex):	Paging
20 @ 32 digits	Call Transfer
Directory Records: 200 @ 32 digits	Networking
Caller ID Records: 200	Requirements:
LCD: English/Spanish, 4 lines x 16 characters	Common Line 1
Speakerphone: Half Duplex	600 feet, maximum
3-way Conference	
Clock/Call Timer	
Tone/Pulse	
Mixed Tone/Pulse Dialing	
Flash: 600ms/100ms-1200ms	
Distinctive Ring Compatible	

UZ634ZT

420 M1S1 10/12/01
Printed in China